

4K Monitor Base Bracket

HB-5055-H



Specifications

Model	HB-5055-H
Dimension(W*H*D) (mm)	242.9*70.41*65.53
Package dimensions (W*H*D)(mm)	260*100*70
Weight(g/PCS)	58
Material	Plastic

Dimensions

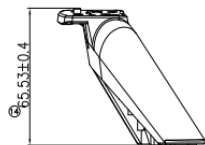
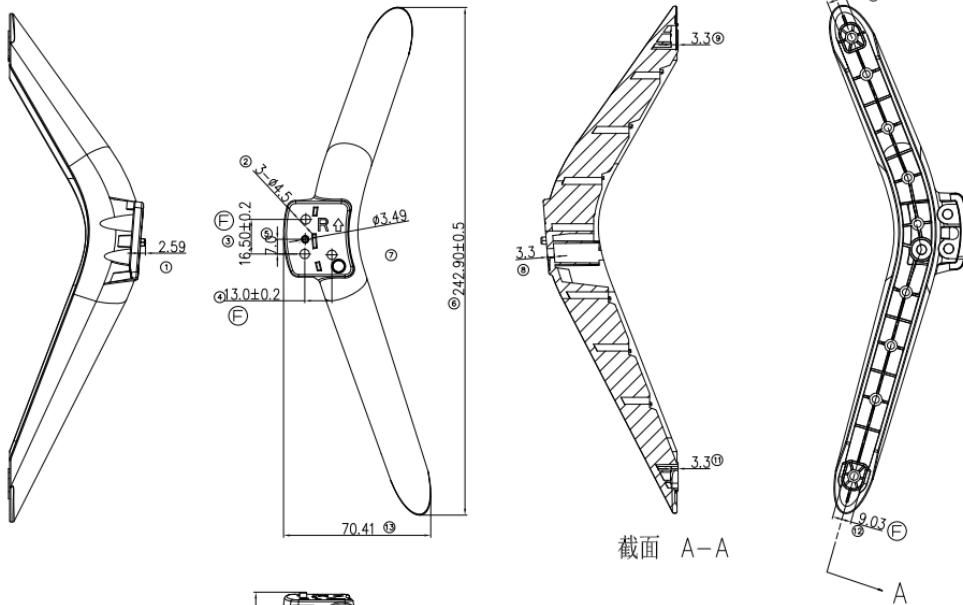
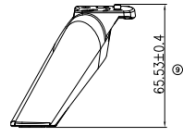
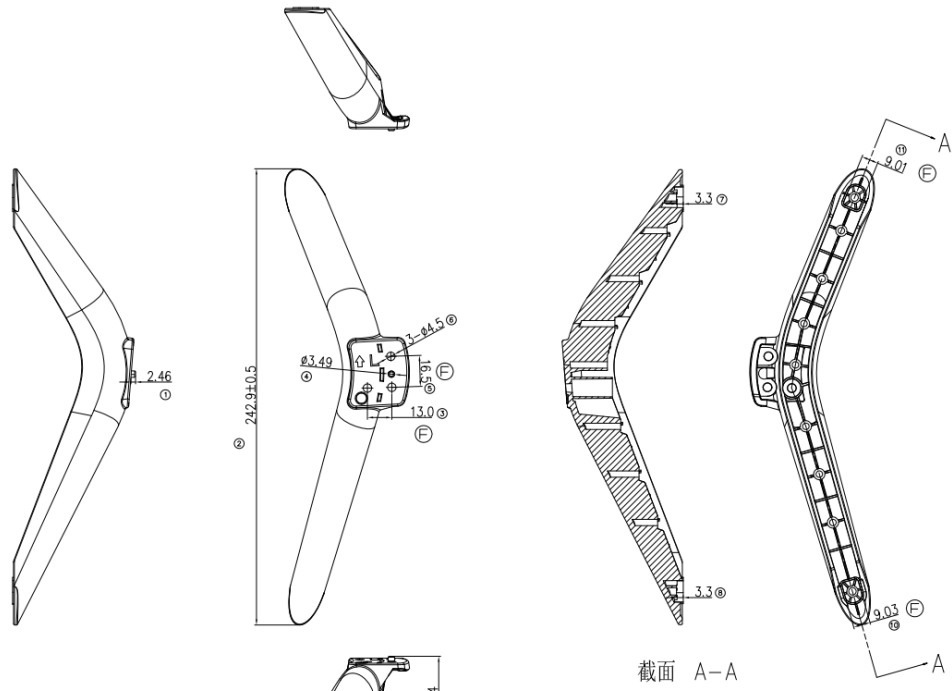

Zhejiang Uniview Technologies Co.,Ltd.

Building No.10, Wanlun Science Park, Jiangling Road 88, Binjiang District, Hangzhou, Zhejiang, China

Email: overseasbusiness@uniview.com; globalsupport@uniview.com

<http://www.uniview.com>

©2022 Zhejiang Uniview Technologies Co.,Ltd. All rights reserved.

*Product specifications and availability are subject to change without notice.